

		1C
GIN IDLE	X0	0
BALE MADE 1	X1	1
BALE MADE 2	X2	2
GIN STARTUP 1	X3	3
		2C
GIN SHUTDOWN 1	X4	4
GIN STARTUP 2	X5	5
GIN SHUTDOWN 2	X6	6
GIN STARTUP 3	X7	7
		3C
GIN SHUTDOWN 3	X8	8
USER DISCRETE 1	X9	9
USER DISCRETE 2	X10	10
FUTURE USE	X11	11
		4C
FUTURE USE	X12	12
FUTURE USE	X13	13
FUTURE USE	X14	14
FUTURE USE	X15	15

CARD #1 / BX-16ND3 / 24VDC INPUT x16

1C	+			
0	-	A1 A2	Y0	GIN IDLE
1	-	A1 A2	Y1	USER ALARM 1 (INCOMING)
2	-	A1 A2	Y2	USER ALARM 2 (AFTER DRYING)
3	-	A1 A2	Y3	USER ALARM 3 (BALE)
2C	+			
4	-	A1 A2	Y4	USER ALARM 4 (SEED)
5	-	A1 A2	Y5	USER ALARM 5 (FLOW ANALYZER)
6	-	A1 A2	Y6	USER ALARM 6 (HOPPER/MAESTRO)
7	-	A1 A2	Y7	PLANNED FUTURE USE
3C	+			
8	-	A1 A2	Y8	PLANNED FUTURE USE
9	-	A1 A2	Y9	PLANNED FUTURE USE
10	-	A1 A2	Y10	PLANNED FUTURE USE
11	-	A1 A2	Y11	FUTURE USE
4C	+			
12	-	A1 A2	Y12	FUTURE USE
13	-	A1 A2	Y13	FUTURE USE
14	-	A1 A2	Y14	FUTURE USE
15	-	A1 A2	Y15	FUTURE USE

CARD #2 / BX-16TR / RELAY OUTPUT x16

RELAY TERMINAL BLOCK NOTES

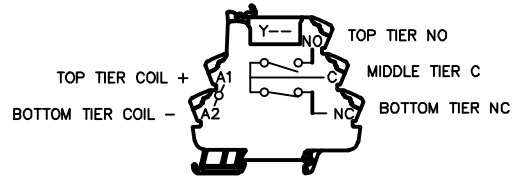

THREE AND TWO TIER TERMINAL BLOCK NOTES

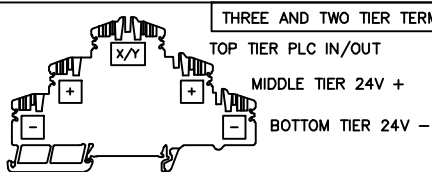

TOP TIER -mA
BOTTOM TIER +mA

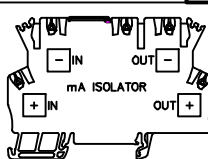

SAMUEL JACKSON, INC.

MIRROR SPECTRUM
PRIMARY CONTROL
PANEL WIRING
PAGE 1 OF 2

CAB3605
12-2018

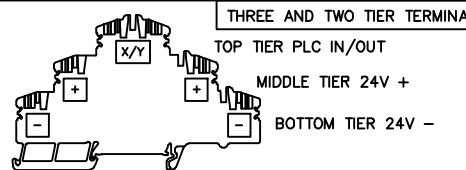
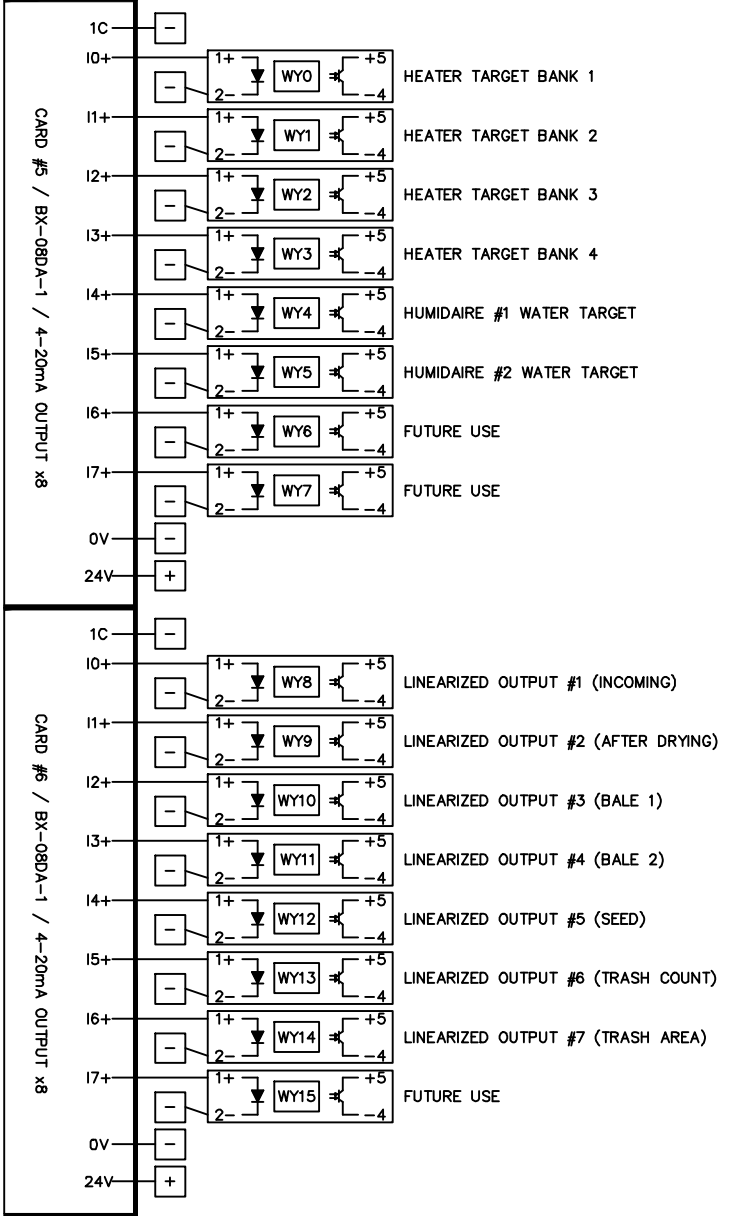
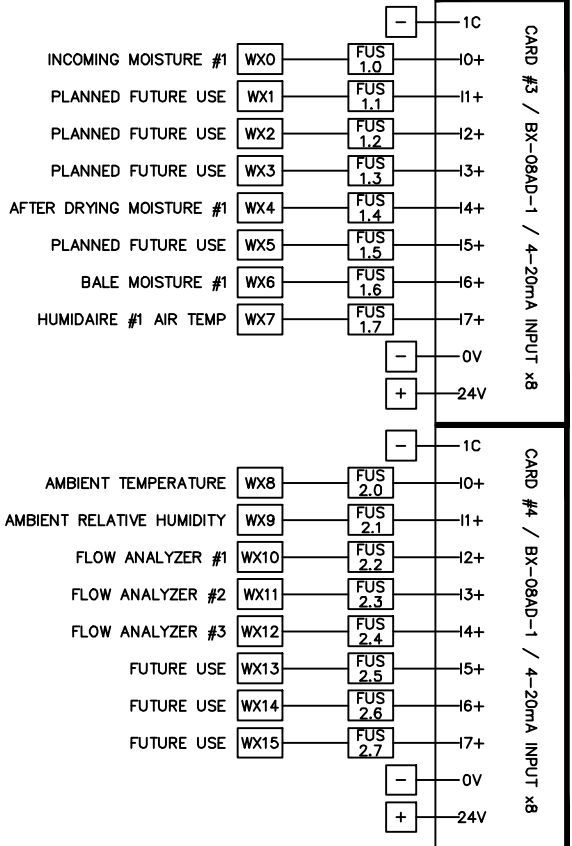

THREE AND TWO TIER TERMINAL BLOCK NOTES

TOP TIER -mA
BOTTOM TIER +mA

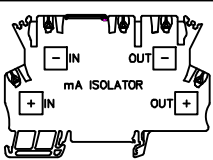

SAMUEL JACKSON, INC.

MIRROR SPECTRUM
PRIMARY CONTROL
PANEL WIRING
PAGE 2 OF 2

CAB3606
12-2018