

RELAY TERMINAL BLOCK NOTES

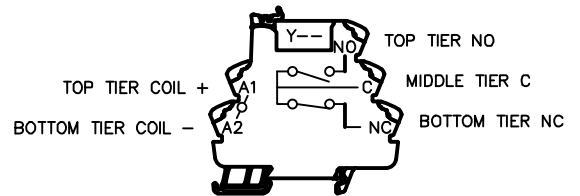

THREE AND TWO TIER TERMINAL BLOCK NOTES

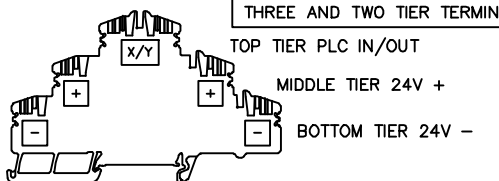

TOP TIER -mA
BOTTOM TIER +mA

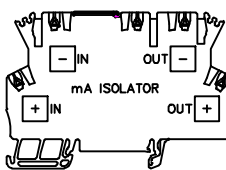

SAMUEL JACKSON, INC.

MIRROR SPECTRUM
PRIMARY CONTROL
PANEL WIRING
PAGE 1 OF 2

CA83605A
06-2023

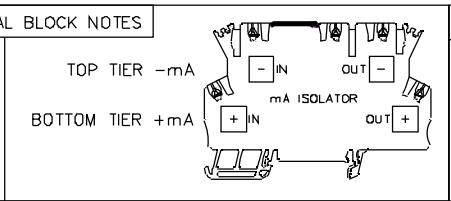
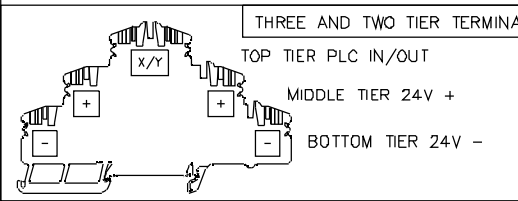
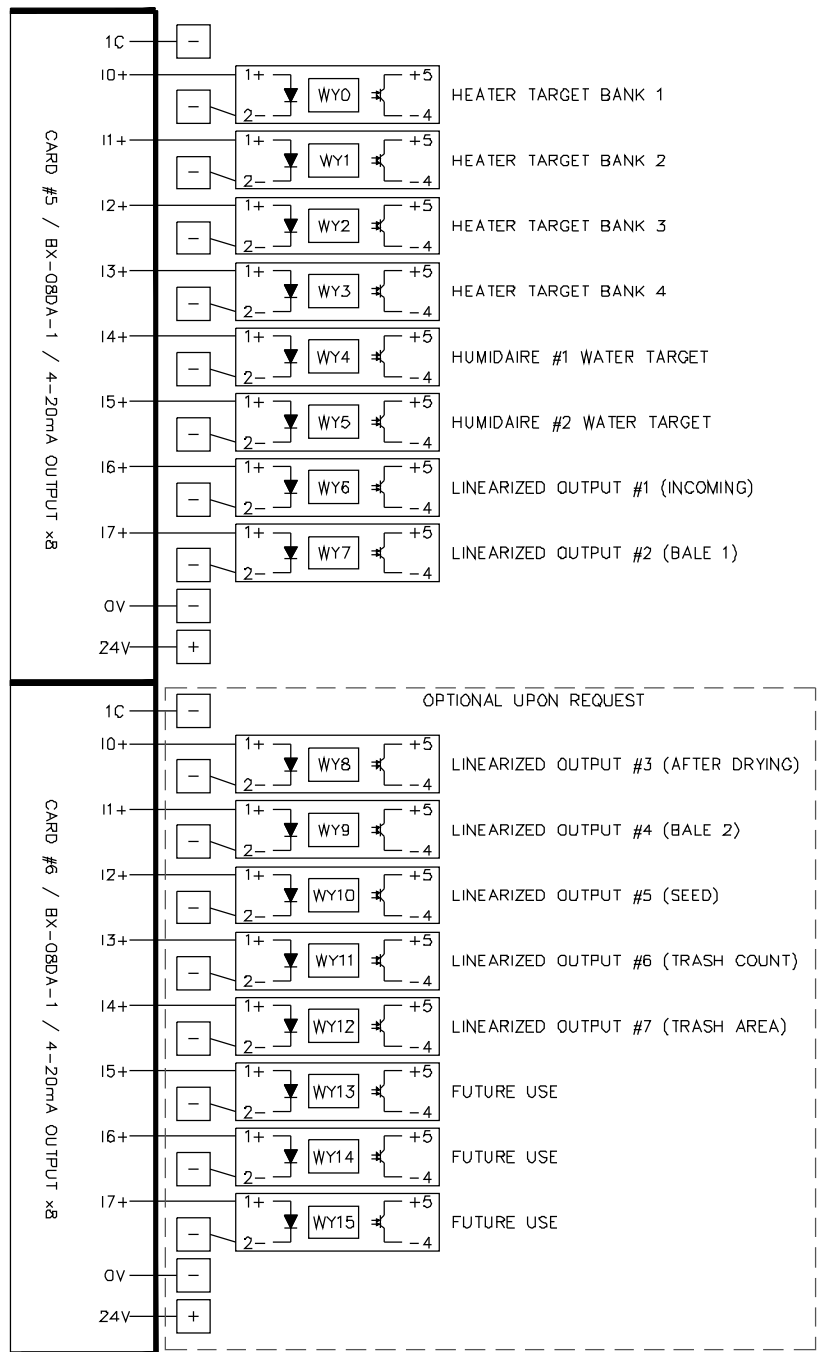
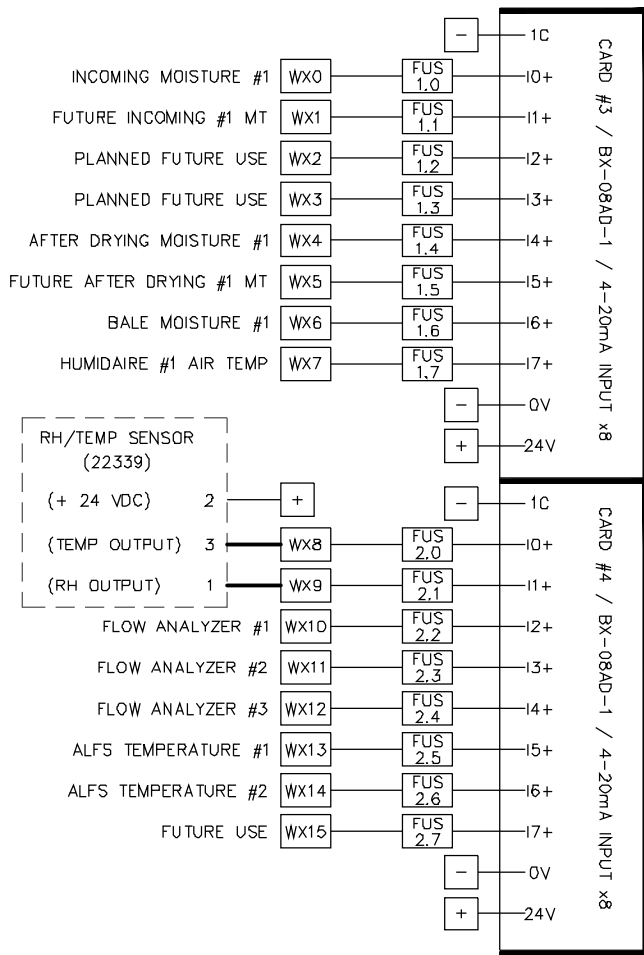

SAMUEL JACKSON, INC.

MIRROR SPECTRUM
PRIMARY CONTROL
PANEL WIRING
PAGE 2 OF 2

CA83606D
01-2023